

RT6338AGQUF, 23V_{IN}, 8A Buck Converter Evaluation Board

General Description

The Evaluation Board demonstrates the RT6338AGQUF to be designed for a programmed between 0.6V to 5.5V/8A output from a 4.5V to 23V input at 500kHz switching frequency. The RT6338AGQUF provides complete protection functions such as input undervoltage-lockout, output undervoltage protection, overcurrent protection and thermal shut down. Cycle-by-cycle current limit provides protection against shorted outputs and soft-start eliminates input current surge during start-up.

Table of Contents

General Description	1
Performance Sepcification Summary	2
Power-up Procedure	2
Detailed Description of Hardware	3
Bill of Materials.....	5
Typical Applications	6
Evaluation Board Layout.....	9
More Information.....	13
Important Notice for Richtek Evaluation Board.....	13

Performance Specification Summary

Summary of the RT6338AGQUF Evaluation Board performance specification is provided in Table 1. The ambient temperature is 25°C.

Table 1. RT6338AGQUF Evaluation Board Performance Specification Summary

Specification	Test Conditions	Min	Typ	Max	Unit
Input Voltage Range		4.5	--	23	V
Output Current		0	--	8	A
Default Output Voltage		--	1.05	--	V
Operation Frequency		--	500	--	kHz
Output Ripple Voltage	$I_{OUT} = 8A$	--	11	--	mVp-p
Line Regulation	$I_{OUT} = 8A, V_{IN} = 4.5V \text{ to } 23V$	--	± 1	--	%
Load Regulation	$V_{IN} = 12V, I_{OUT} = 0.001A \text{ to } 8A$	--	± 1	--	%
Load Transient Response	$V_{OUT} = 1.05V, I_{OUT} = 0.8A \text{ to } 8A$	--	± 5	--	%
Maximum Efficiency	$V_{IN} = 12V, V_{OUT} = 1.05V, I_{OUT} = 2A, VCC_EXT = 5V$	--	91	--	%

Power-up Procedure

Suggestion Required Equipments

- RT6338AGQUF Evaluation Board
- DC power supply capable of at least 25V and 6A
- Electronic load capable of 8A
- Function Generator
- Oscilloscope

Quick Start Procedures

The Evaluation Board is fully assembled and tested. Follow the steps below to verify board operation. Do not turn on supplies until all connections are made. When measuring the output voltage ripple, care must be taken to avoid a long ground lead on the oscilloscope probe. Measure the output voltage ripple by touching the probe tip and ground ring directly across the last output capacitor.

Proper measurement equipment setup and follow the procedure below.

- 1) With power off, connect the input power supply to the VIN and GND pins.
- 2) With power off, connect the electronic load between the VOUT and nearest GND pins.
- 3) Turn on the power supply at the input. Make sure that the input voltage does not exceeds 23V on the Evaluation Board.
- 4) Check for the proper output voltage using a voltmeter.
- 5) Once the proper output voltage is established, adjust the load within the operating ranges and observe the output voltage regulation, ripple voltage, efficiency and other performance.

Detailed Description of Hardware

Headers Description and Placement

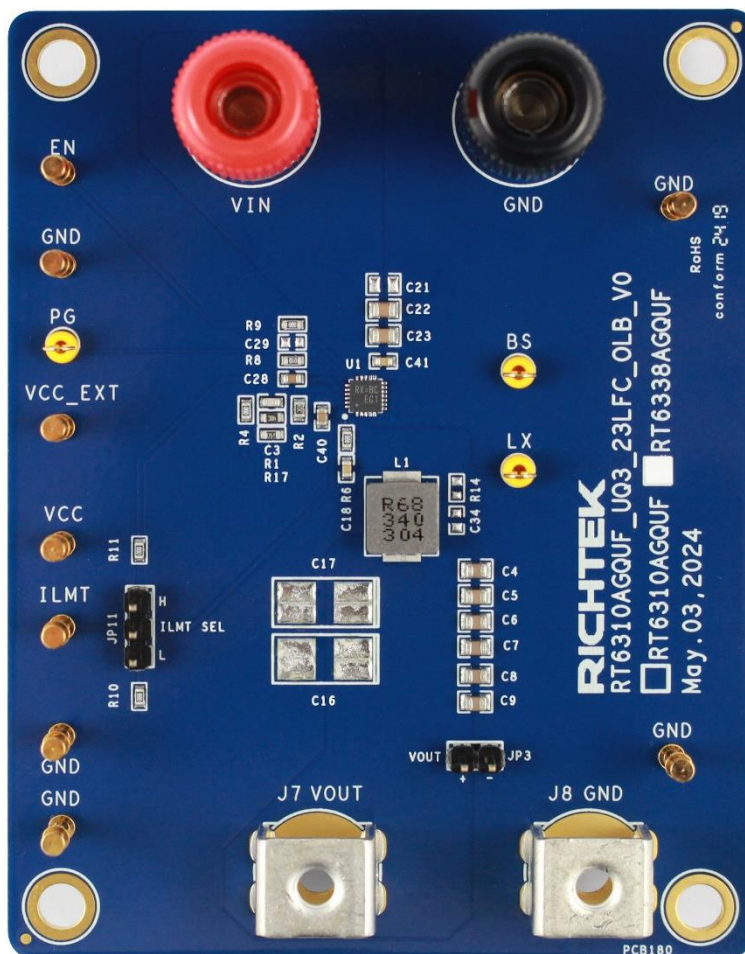

Carefully inspect all the components used in the EVB according to the following Bill of Materials table, and then make sure all the components are undamaged and correctly installed. If there is any missing or damaged component, which may occur during transportation, please contact our distributors or e-mail us at evb_service@richtek.com.

Test Points

The EVB is provided with the test points and pin names listed in the table below.

Test Point/ Pin Name	Function
VIN	Input voltage.
VOUT	Output voltage.
GND	Ground.
EN	Enable and operation mode control input.

Test Point/ Pin Name	Function
VCC_EXT	External voltage input for VCC.
VCC	Internal LDO output. Used as supply to internal control circuits. DO NOT connect to any external loads.
ILMT	Valley current-limit setting pin. 10A: Connect the ILMT pin to PGND. 12A: Leave the ILMT pin floating/open. 14A: Connect the ILMT pin to 5V.
JP11	ILMT jumper. Connect ILMT to VCC,GND or floating.
LX	Switch node test point.
PG	Power good indicator.
BS	Bootstrap test pin.
JP3	VOUT ripple measurement test pin.

Bill of Materials

VIN = 12V, VOUT = 1.05V, IOUT = 8A, fsw = 500kHz						
Reference	Count	Part Number	Value	Description	Package	Manufacturer
U1	1	RT6338A	RT6338AGQUF	Buck Converter	UQFN-23L 3x3 (FC)	RICHTEK
C3	1	0603N680J500CT	68pF	Capacitor, Ceramic, 50V, NPO	0603	WALSN
C4, C5, C6, C7, C8, C9	6	0805X226M6R3CT	22μF	Capacitor, Ceramic, 6.3V, X5R	0805	WALSN
C18, C41	2	0603B104K500CT	0.1μF	Capacitor, Ceramic, 50V, X7R	0603	WALSN
C22, C23	2	0805X106K250CT	10μF	Capacitor, Ceramic, 25V, X5R	0805	WALSN
C28	1	0603X475K6R3CT	4.7μF	Capacitor, Ceramic, 6.3V, X5R	0603	WALSN
C40	1	0603X475K6R3CT	4.7μF	Capacitor, Ceramic, 6.3V, X5R	0603	WALSN
L1	1	PEUE063T-R68MS	0.68μH	Inductor, Isat = 18.5A, 4.3mΩ	7.3x6.8x3mm	CYNTEC
R1	1	RTT033092FTP	30.9k	Resistor, Chip, 1/10W, 1%	0603	RALEC
R2	1	RMC16K4122FTP	41.2k	Resistor, Chip, 1/10W, 1%	0603	KAMAYA
R4, R6, R9, R10, R11	5	WR06X000 PTL	0	Resistor, Chip, 1/10W, 1%	0603	WALSIN
R8	1	WR06X1003FTL	100k	Resistor, Chip, 1/10W, 1%	0603	WALSIN
R17	1	WR06W1R10FTL	1.1	Resistor, Chip, 1/10W, 1%	0603	WALSIN

Typical Applications

EVB Schematic Diagram

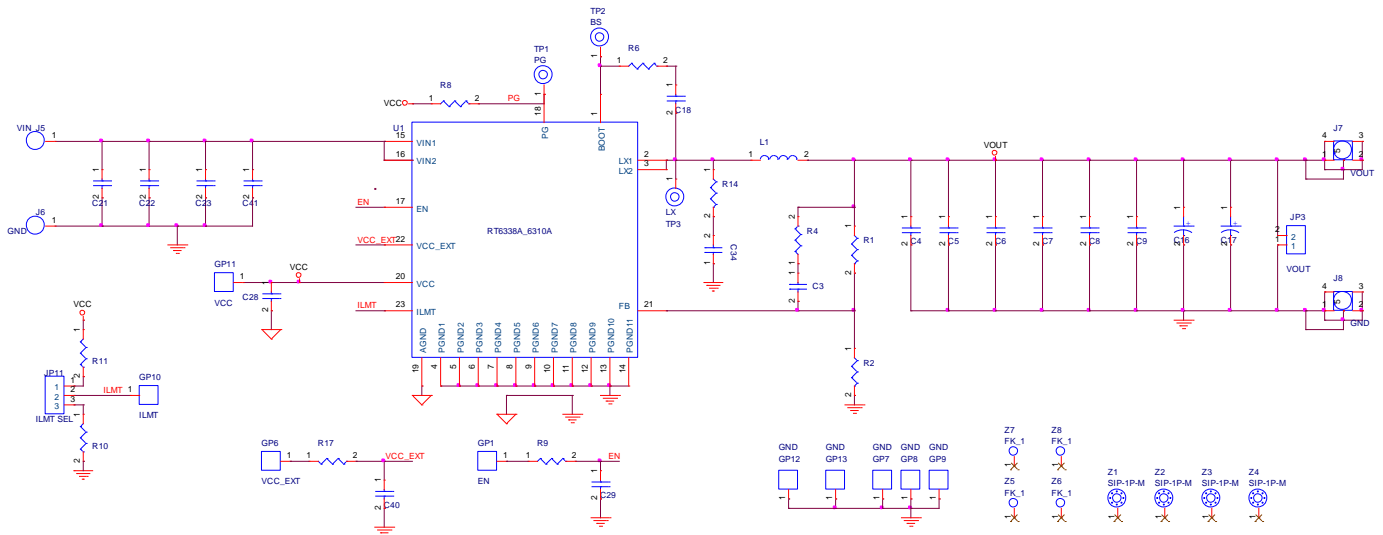

1. The capacitance values of the input and output capacitors will influence the input and output voltage ripple.
2. MLCC capacitors have degrading capacitance at DC bias voltage, and especially smaller size MLCC capacitors will have much lower capacitance.

Measure Result

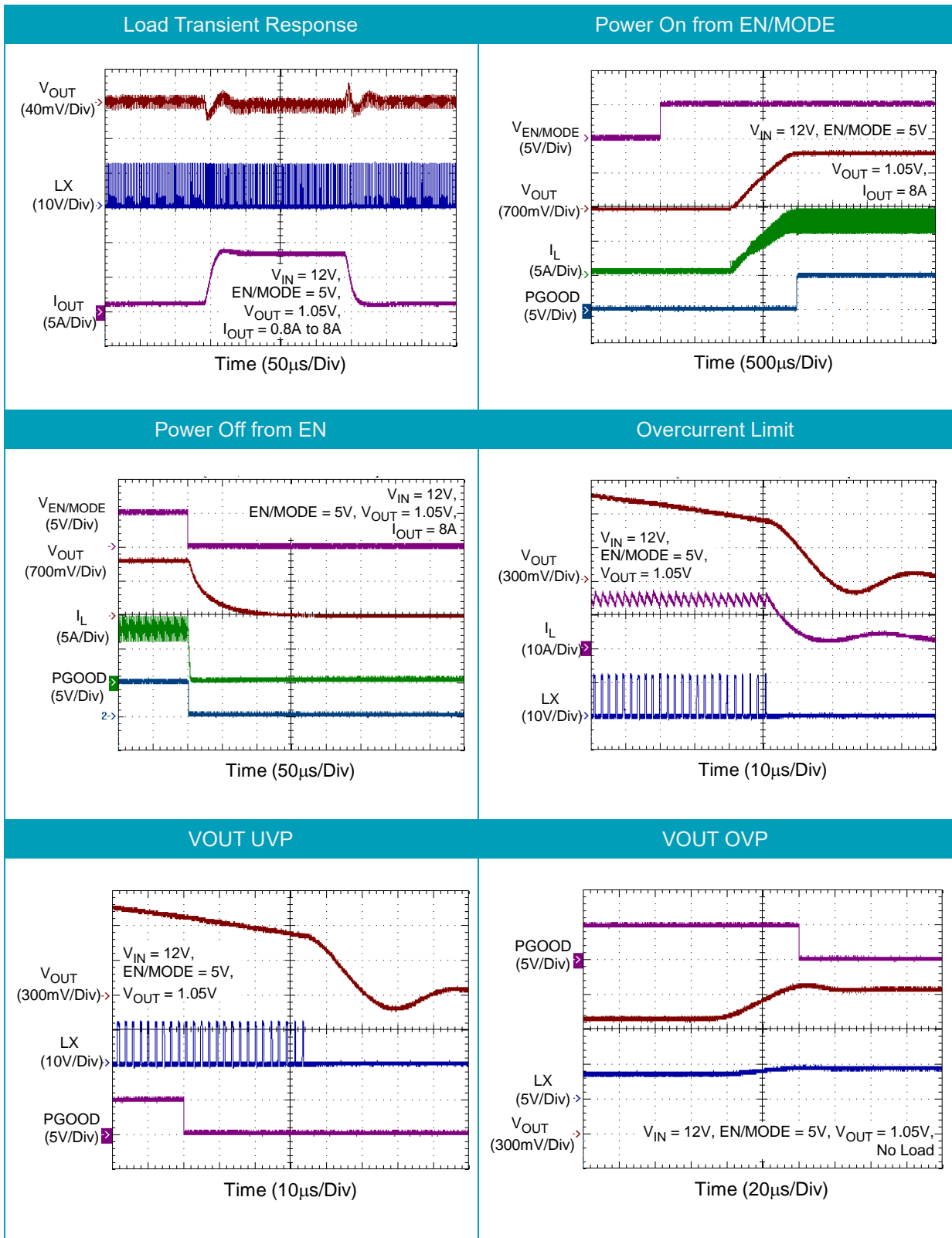

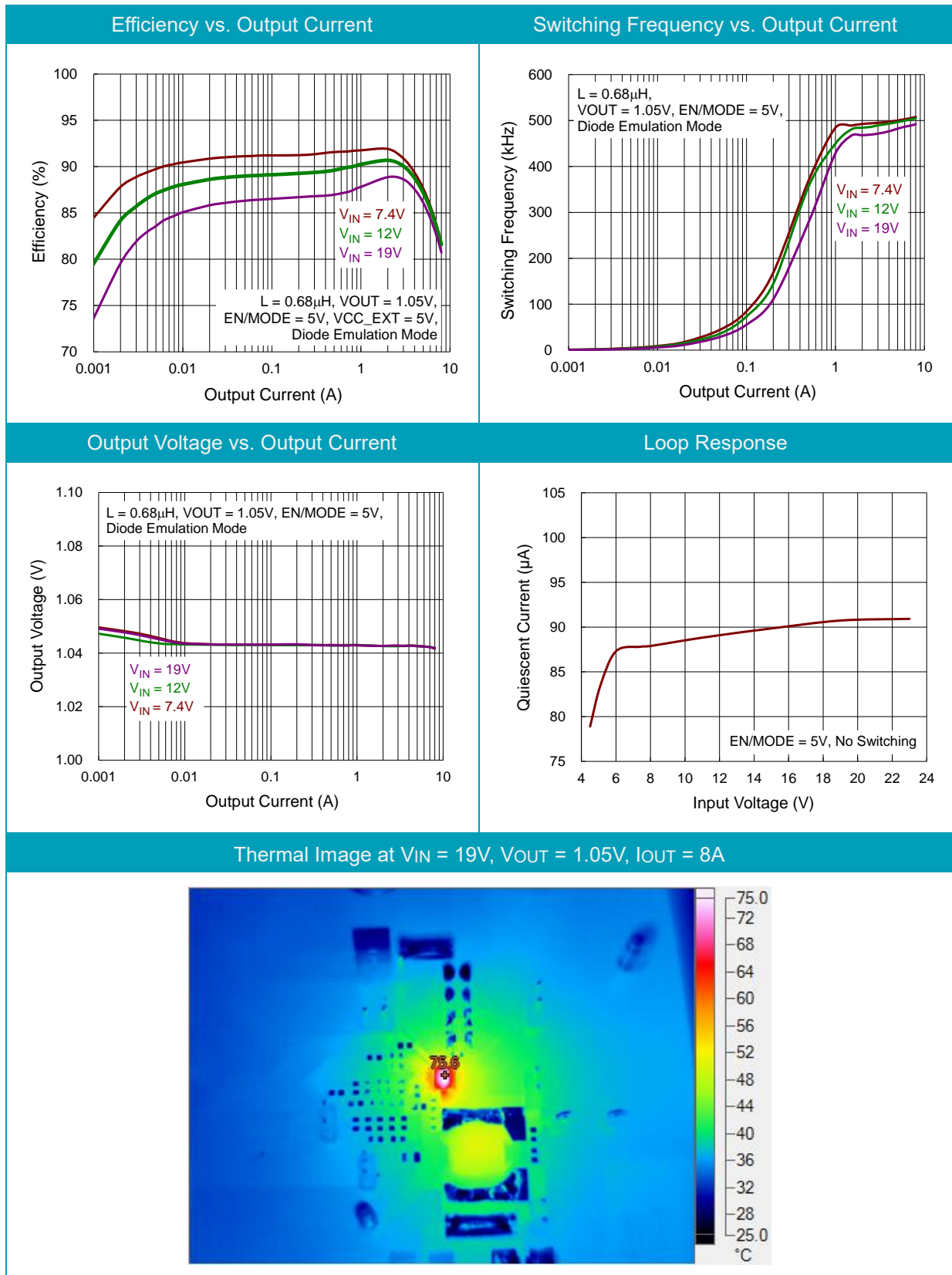

Note: When measuring the input or output voltage ripple, care must be taken to avoid a long ground lead on the oscilloscope probe. Measure the output voltage ripple by touching the probe tip directly across the output capacitor.

Evaluation Board Layout

Figure 1 to Figure 4 are RT6338AGQUF Evaluation Board layout. This board size is 90mm x 70mm and is constructed on four-layer PCB, outer layers with 2 oz. Cu and inner layers with 1 oz. Cu.

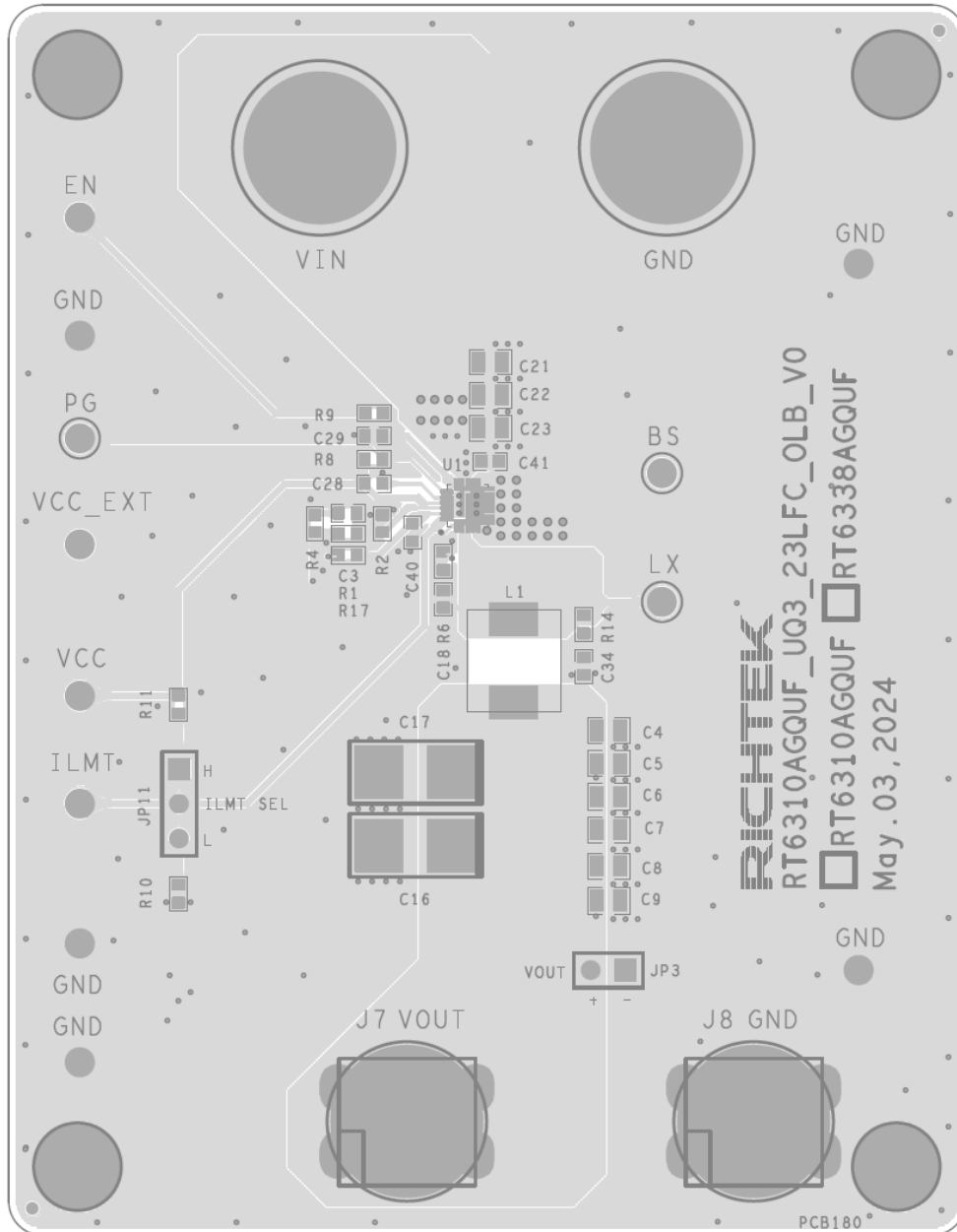

Figure 1. Top View (1st layer)

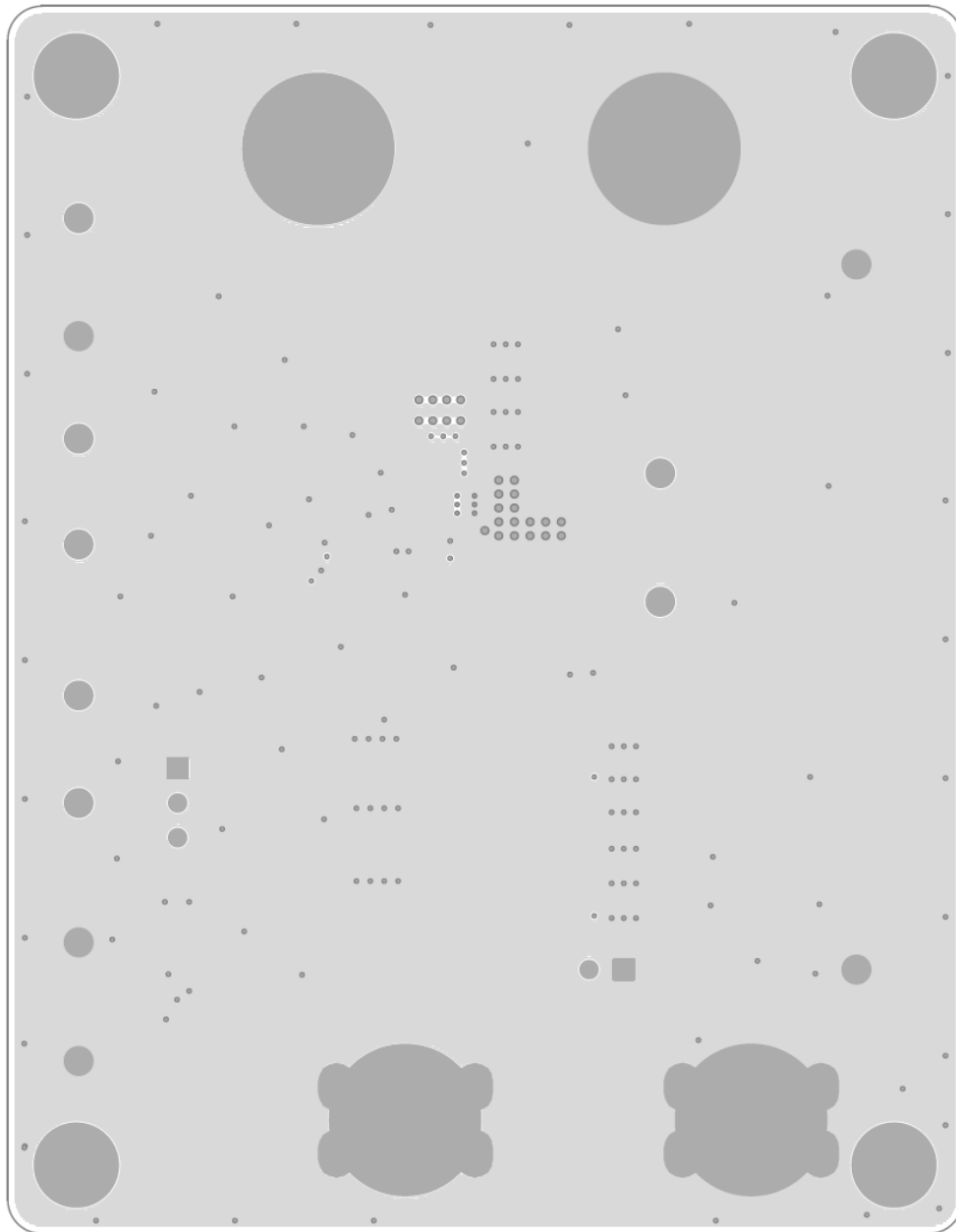

Figure 2. PCB Layout—Inner Side (2nd Layer)

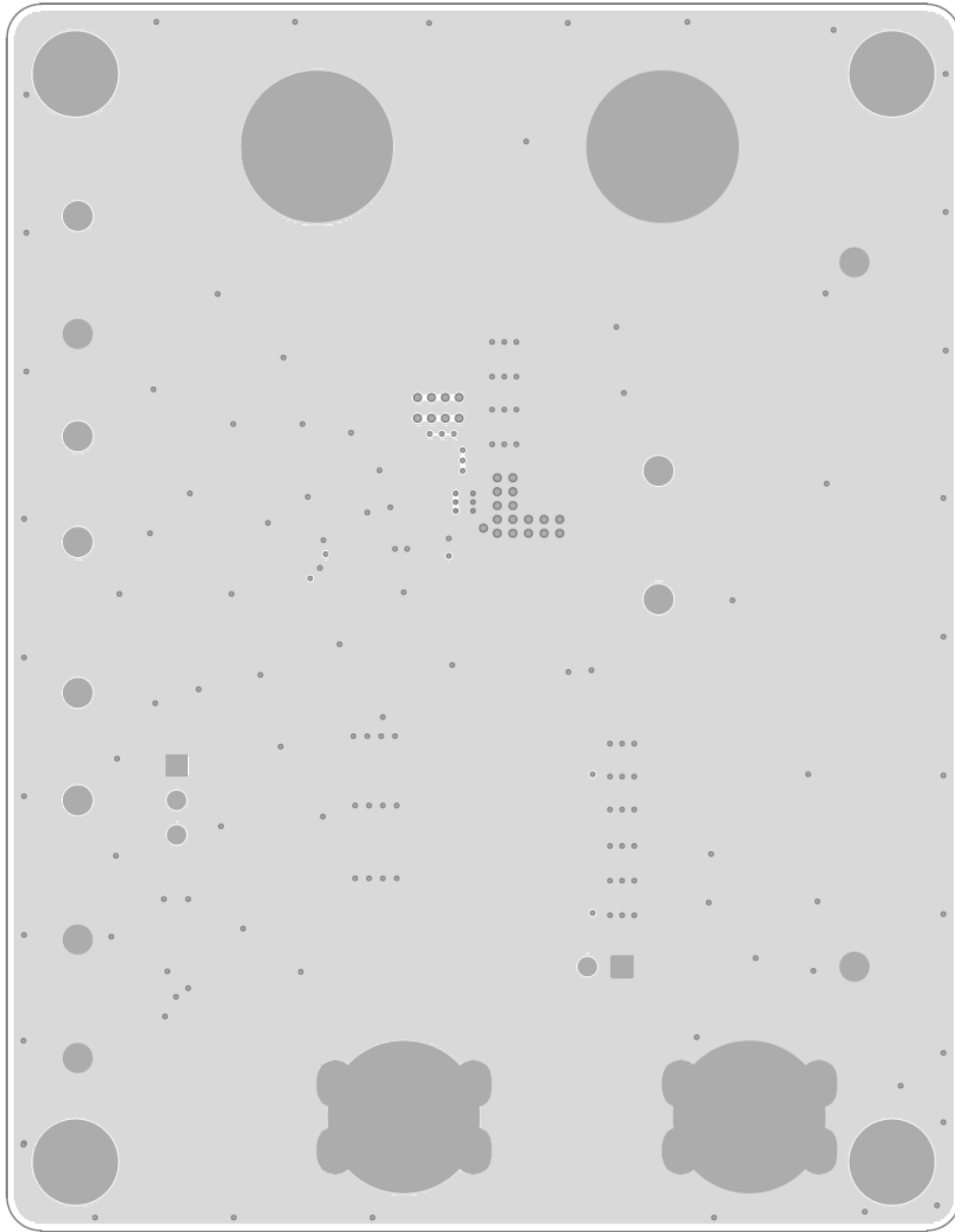

Figure 3. PCB Layout—Inner Side (3rd Layer)

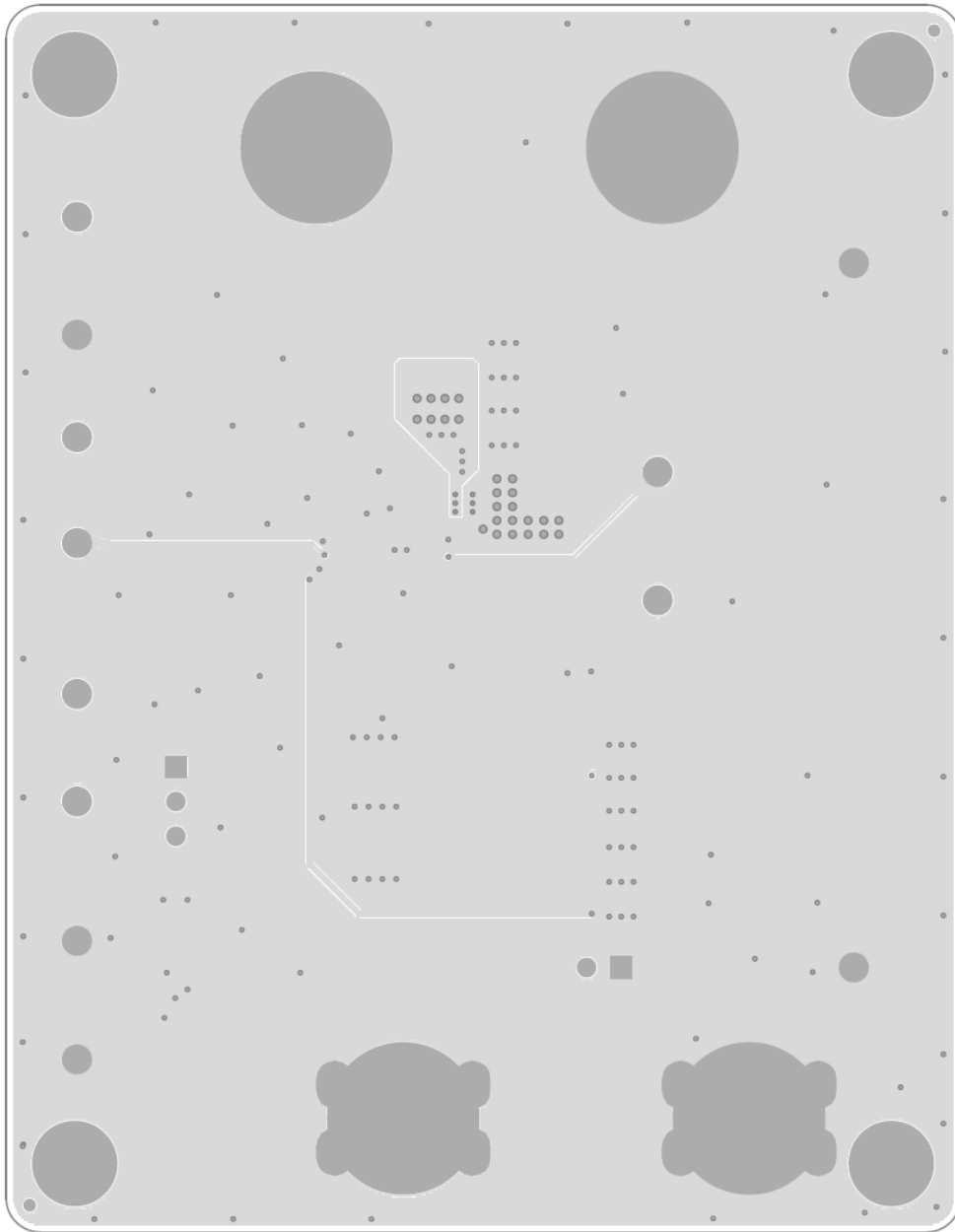

Figure 4. Bottom View (4th Layer)

More Information

For more information, please find the related datasheet or application notes from Richtek website
<http://www.richtek.com>.

Important Notice for Richtek Evaluation Board

THIS DOCUMENT IS FOR REFERENCE ONLY, NOTHING CONTAINED IN THIS DOCUMENT SHALL BE CONSTRUED AS RICHTEK'S WARRANTY, EXPRESS OR IMPLIED, UNDER CONTRACT, TORT OR STATUTORY, WITH RESPECT TO THE PRESENTATION HEREIN. IN NO EVENT SHALL RICHTEK BE LIABLE TO BUYER OR USER FOR ANY AND ALL DAMAGES INCLUDING WITHOUT LIMITATION TO DIRECT, INDIRECT, SPECIAL, PUNITIVE OR CONSEQUENTIAL DAMAGES.